

VHF Airband Transceiver

JHP-500 Com & JHP-520 Nav/Com

Operation Manual

JRC *Japan Radio Co., Ltd.*

352-0104-0 Rev. 050300

TABLE OF CONTENTS

	page		page
INTRODUCTION / BEFORE USE	i		
WARNINGS / CAUTIONS	ii - iv	◆ NAV-Scan	18
WARRANTY	4	◆ Weatherband Scanning	19
ABBREVIATIONS	5	◆ Memory Scanning	19
SPECIFICATIONS	6	◆ Dual-Watch	19
● PRE-OPERATION	6 - 9	● MEMORY	20 - 22
◆ Unpacking	6	◆ Instant Memory Write	20
◆ Assembly	7	◆ Programming Memory Manually	20
◆ Battery Charging	8	◆ Alpha Numeric Comment Programming	21
◆ Accessory Operation	9	◆ Accessing Memory Channels	21
● PANEL FEATURES	10 - 15	◆ Lock Out Feature	22
◆ Display	10	◆ Deleting a Memory Channel	22
◆ Nav Display	11	● MISC. OPERATION	22 - 25
◆ Front & Side Panel	12	◆ Duplex	22
◆ Keypad Layout	13	◆ Battery Save	23
◆ Quick Buttons™	13	◆ Key Tone "Beep"	23
◆ Keypad Functions	14 - 15	◆ Automatic Noise Limiter "ANL"	23
● BASIC OPERATION	16 - 17	◆ Lamp / Backlighting	23
◆ Power, Volume & Squelch	16	◆ Key Lock	23
◆ Airband Frequency Selection	16	◆ Battery Selector	24
◆ Weatherband Channel Selection	17	◆ Radio Reset	24
◆ Emergency 121.5 Selection	17	◆ Low Power / High Power	24
◆ Receiving & Transmitting	17	◆ Com Frequency Steps	24
● SCANNING	18 - 19	◆ Nav Frequency Steps	25
◆ Scan Pause Feature	18	● VOR OPERATION	25 - 27
◆ Com Band Scanning	18	◆ DVOR Mode	25
		◆ CDI Mode	26
		● TROUBLESHOOTING	27

ABBREVIATIONS

ANL	Automatic Noise Limiter: JRC radios feature advanced ANL circuitry. When activated the ANL circuit will filter out unwanted aircraft ignition and static noise. (p.10,14,23)	FROM	"FROM" (in VOR/CDI operation) Indicates the aircraft position in reference to flying away from a VOR station. (p.11,14,26)
A/S	Active or Standby Frequency Control: Also known as "flip-flop" frequency control. The ability to select between the active and standby frequency at the press of one button. (p.13,14)	IMW	Instant Memory Write: Instantly transfers the displayed frequency to memory at the press of a button. (p.13,14,20)
Battery Save	Periodical turn-on of the receiving operation in order to extend the battery's operating time. (p.10,15,23)	Key Lock	All keys except the function, lamp and PTT buttons become inoperative. (p.10,15,23)
BEEP	When a button is pressed a "Beep tone" will sound. (p.14,23)	Lock Out	Memory channels that are "Locked Out" will not be scanned. (p.10,15,19,22)
CDI	Course Deviation Indicator: Displays the aircraft's reference location right or left of the desired course either TO or FROM a VOR station. (p.11,15,26)	NAV	Navigation
COM	Communication (p.17)	NOAA	National Oceanic and Atmospheric Administration
DVOR	Digital VOR: Digitally displays the aircraft's bearing either TO or FROM a VOR station. (p.11,15,25)	OBS	Omni Bearing Selector
Dual Watch	Two frequencies are monitored at the same time. (p.15,19)	Pause	When scanning, the unit will lock on to an active frequency for approximately five seconds then continue to scan. (p.18)
Duplex	The ability to transmit on one frequency and receive on another frequency. (p.10,15,22)	TO	"TO" (in VOR/CDI operation) Indicates the aircraft position in reference when flying to a VOR station. (p.11,15,26)
		VOR	VHF Omni Range: The standard short to medium range aeronautical navigational system. The system allows for determining the bearing of an aircraft in reference to a specific VOR station. (p.25)

5

SPECIFICATIONS

- Frequency Range Transmit
Com: 118.000 ~ 136.975 MHz
- Frequency Range Receive:
Nav: 108.000 ~ 117.975 MHz
NOAA Weather Channels: 01 ~ 10
- Operating Voltage: 12V±10%
- Output Power: 5W (PEP)
- Input Current:
Transmit: approx. 1A
Receiving: approx. 250mA
Standby: approx. 60mA
- Antenna Impedance: typ. 50Ω
- Frequency Stability: ±10ppm
- Tuning Steps: 25kHz
- Memory Channels: 100
- Mode: AM (6K00A3E), FM (11K0F3E)
- Operating Temperature: -10°C to +50°C
- Weight: approx. 15.5 oz. with Ni-Cd battery
- Dimensions: (without antenna)
2-3/16" W x 6-9/16" H x 1-5/16" D

PRE-OPERATION

● PRE-OPERATION

◆ *Unpacking*

STANDARD ACCESSORIES

The JHP-500/520 transceivers include the following standard accessories.

- Headset adapter (800-0046-0)
- Ni-Cd 700mA battery pack (NBB-487)
- Flex antenna (NAV-151)
- Belt clip with screws, attaches to transceiver (310-0019-0)
- Wall charger 120VAC (NBB-484)
- Protective case (334-0120-0)
- Wrist strap (390-0043-0)
- Operations manual (352-0104-0)

OPTIONAL ACCESSORIES

The following optional accessories are available for the JHP 500/520:

- Alkaline battery pack, 9 AA batteries (NBB-488)
- Ni-Cd 700mA battery pack (NBB-487)
- Ni-MH 1200mA battery pack (NBB-479)
- Wall charger 220VAC (NBB-485)
- Desktop rapid charger 120VAC (NBB-486)
- Cigarette lighter power adapter, 12VDC (CFQ-6132)
- Speaker microphone (NVT-145)

6

PRE-OPERATION

◆ Assembly

Antenna

The antenna and transceiver use a standard BNC connection.

• To attach antenna to transceiver:

- 1) Place the antenna BNC connector onto the transceiver BNC connector.
- 2) Rotate the antenna BNC connector clockwise until it stops.

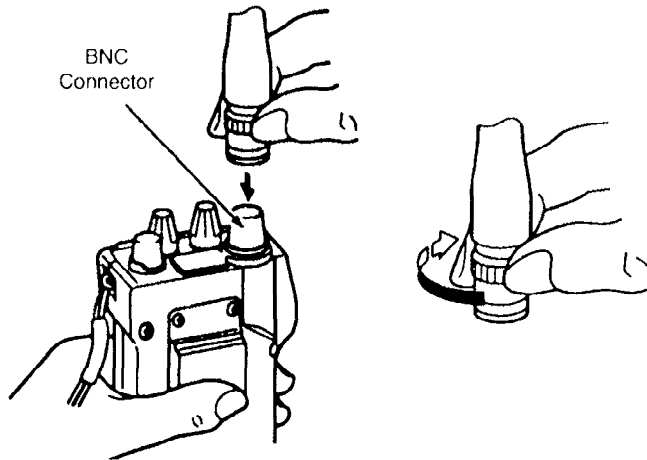

Battery

• To attach battery pack to transceiver:

- 1) Slide battery pack onto transceiver until it stops.

• To remove battery pack from transceiver:

- 1) Lift battery release lever.
- 2) Slide battery pack off transceiver.

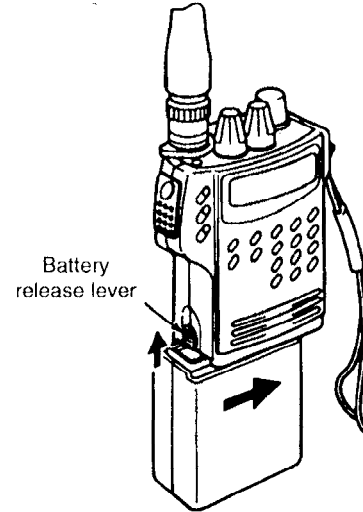

7

PRE-OPERATION

◆ Battery Charging

- Do not charge at ambient temperature below 0° C (32° F) or above 40° C (104° F).
- Do not operate JHP-500/520 while charging the battery.
- The battery does not need to be attached to the transceiver to charge.

Wall Chargers

General notes for charging the NBB-487 Ni-Cd 700mA and NBB-479 Ni-MH 1200mA battery packs using the NBB-484 120VAC and NBB-485 220VAC wall chargers.

- 1) Connect the wall charger to the battery.
 - The battery will fully charge in approximately ten (10) hours.
 - Do Not exceed a charging time of fifteen (15) hours.

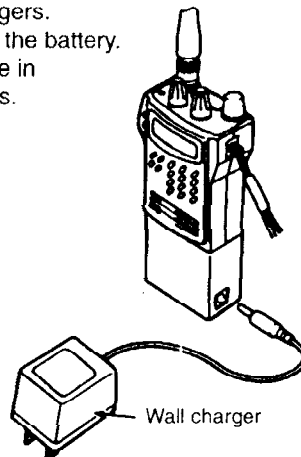

Desktop Rapid Charger

- 1) Insert battery into the charger.
 - The battery will fully charge in approximately two (2) hours.
 - Refer to NBB-486 desktop rapid charger operating instructions for complete details.

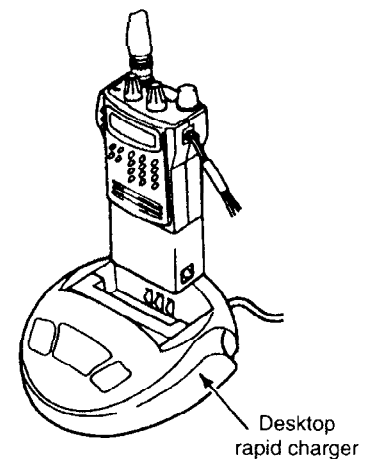

Please Note: When the battery charge drops below the minimum operating voltage, "BATT" will flash on the LCD display signifying that the battery needs to be charged.

8

PRE-OPERATION

◆ Accessory Operation

Cigarette Lighter Adapter

The CFQ-6132 cigarette lighter adapter includes the (CFQ-6132A) DC cable and the (CFQ-6132B) power module.

- The (CFQ-6132A) should not be used to charge batteries.
- The (CFQ-6132) should only be used with a 12VDC power source.

- 1) Remove battery pack.
- 2) Attach the (CFQ-6132B) power module to transceiver.
- 3) Connect the (CFQ-6132A) DC cable to the (CFQ-6132B) power module and to a 12VDC cigarette lighter input.
 - Refer to CFQ-6132 cigarette lighter adapter operating instructions for complete details.

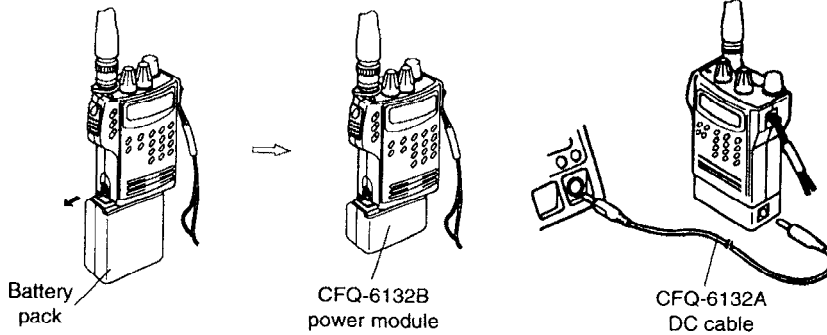

9

Headset Adapter

- The headset adapter is designed to be used with a standard aviation headset. Some stereo aviation headsets may not be compatible with the adapter.
- Side tone is output to the headset when transmitting.

- 1) Attach the headset adapter to the radio microphone and speaker jacks located next to the antenna connection.
- 2) Attach the headset adapter to a standard aviation headset.

Speaker Microphone

- 1) Attach the speaker microphone to the radio microphone and speaker jacks located next to the antenna connection.
 - Refer to NVT-145 speaker microphone operating instructions for complete details.

PANEL FEATURES

● PANEL FEATURES

◆ Display JHP-500/520

1. **DUP INDICATOR**
Appears when the duplex function is activated.
2. **STBY INDICATOR**
Appears when the standby Dual Watch frequency is displayed.
3. **ACT INDICATOR**
Appears when an active airband frequency is displayed.
4. **FUNCTION INDICATOR**
Appears for approximately three seconds when either of the function buttons are pressed.
5. **KEY LOCK INDICATOR**
Appears when the key lock function is activated.
6. **SAVE INDICATOR**
Appears when the battery save function is activated.
7. **ANL INDICATOR**
Appears when the active noise limiter function is activated.
8. **BATT INDICATOR**
Appears when the battery voltage drops below operating limits signifying that the battery needs to be charged.
9. **LOW INDICATOR**
Appears when the low power function is activated.
10. **M INDICATOR**
Appears when the memory mode is activated.
11. **LOCK OUT INDICATOR**
Appears when the selected memory channel is programmed to locked out.
12. **SCAN INDICATOR**
Appears when the scan function is activated.
13. **MEMORY CHANNEL INDICATOR**
Displays memory channel number 00 - 99.
14. **FREQUENCY/ CHANNEL DISPLAY**
Displays frequency/channel number.

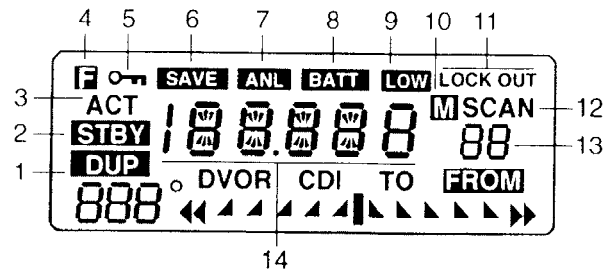

10

PANEL FEATURES

◆ Nav Display JHP-520

1. **COURSE DISPLAY**
 - Displays aircraft location on a VOR radial in DVOR mode.
 - Displays desired radial in CDI mode.
2. **DVOR INDICATOR**
Appears when DVOR function is activated.
3. **CDI INDICATOR**
Appears when CDI function is activated.
4. **TO INDICATOR**
Appears when VOR navigation is based on a course leading to the VOR station.
5. **FROM INDICATOR**
Appears when VOR navigation is based on a course leading away from a VOR station.
6. **COURSE DEVIATION SCALE**
Displays the left/right deviation between the desired course and the actual course in 2° increments.

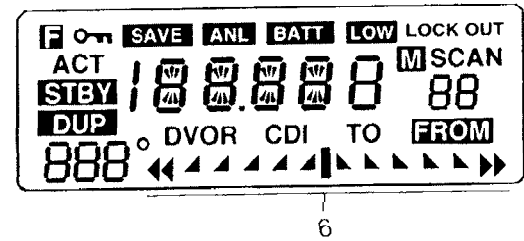
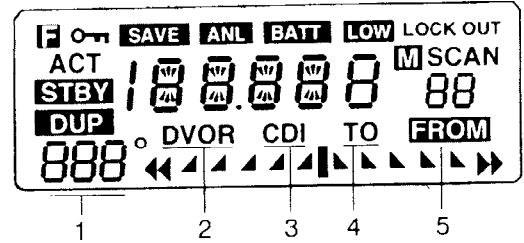

11

PANEL FEATURES

◆ Front & Side Panel

1. PUSH TO TALK BUTTON (PTT)
2. FUNCTION BUTTON
3. BNC ANTENNA CONNECTOR (FEMALE)
4. SQUELCH CONTROL KNOB
5. VOLUME CONTROL / POWER ON-OFF KNOB
6. CHANNEL SELECTOR
7. LCD DISPLAY
8. KEYPAD
9. BELT CLIP
10. BATTERY RELEASE LEVER

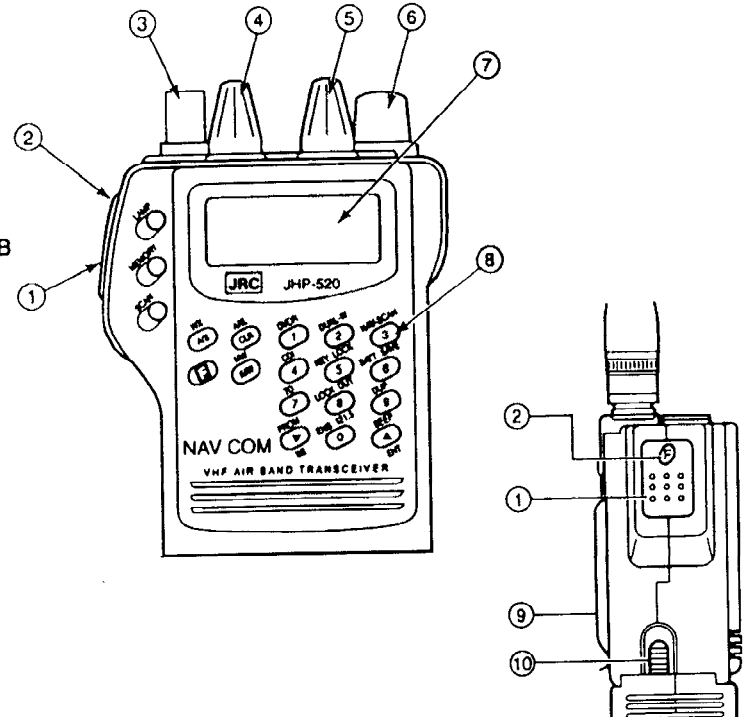

12

PANEL FEATURES

◆ Keypad Layout

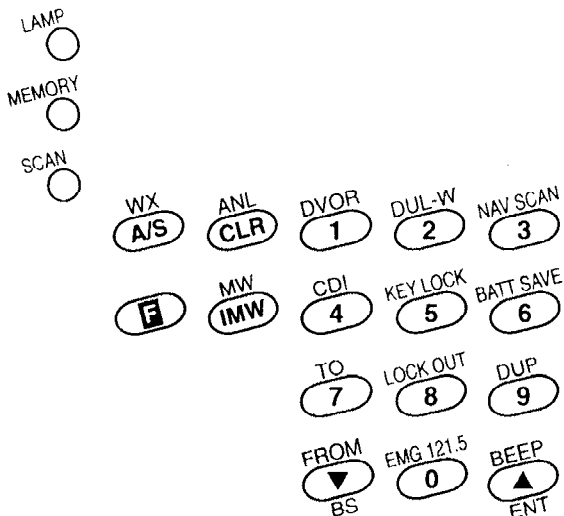

Please Note: The following is omitted from the JHP-500 keypad button identification: DVOR, CDI, TO, FROM

◆ Quick Buttons™



The JHP-500/520 was designed especially for the aviation environment with an exclusive user friendly feature called Quick Buttons™. Quick Buttons™ are dedicated buttons that activate specific functions at the press of a single button, eliminating the two step process for the most useful functions.



Active/Standby

Toggles between an active and a standby frequency.



Instant Memory Write

Instantly transfers the displayed frequency/channel to memory.



Memory

Instant access to memory channels.



Scan

Instantly starts scanning the desired mode.



Clear

Instantly returns to the airband frequency mode.



Lamp

Turn on & off the backlight display and keypad.

PANEL FEATURES

◆ Keypad Functions

KEY	Main Function	Secondary Function (after pressing F)
LAMP	Turns the display and keypad lamp on. The lamp will remain on for approximately five seconds.	Continuous lamp function. The lamp will remain on until the lamp button is press.
MEMORY	Accesses the memory mode.	None
SCAN	Instantly starts scanning the active mode.	None
WX A/S	Toggles between an active and a standby frequency/channel	Activates the Weather Channels.
ANL CLR	Exits or stops the following modes/functions: weather, memory, dual watch, duplex, scan.	Activates the Active Noise Limiter function.
F	Activates the secondary functions/features.	When pressed and held for two seconds the "F" will flash activating third function features.
MW IMW	Instantly transfers the displayed frequency/channel to memory.	• Activates the Memory Write features. • Toggles between the frequency and alpha/numeric display in memory mode.
FROM BS	• Changes the frequency/channel. • When pressed and held it will rapidly scroll through frequencies, channels or memory. • Changes scan direction. • "Back Spaces" when programming.	Changes the CDI/DVOR navigational information to "FROM" when using an active VOR frequency.
BEEP ENT	• Changes the frequency/channel. • When pressed and held it will rapidly scroll through frequencies, channels or memory. • Changes scan direction. • "Enters" programming step functions.	Turns the Beep Tones on and off.

PANEL FEATURES

KEY	Main Function	Secondary Function (after pressing F)
DVOR 1	All numbered keys will do the following: AIRBAND MODE • Selects the desired airband frequency. WEATHER MODE • Selects the desired weather channel. MEMORY MODE • Selects the desired memory location. NAVIGATION VOR CDI MODE • Selects the desired bearing/radial.	Selects the DVOR feature when using an active VOR frequency.
DUL-W 2		Activates the Dual Watch feature.
NAV SCAN 3		Starts scanning the VOR navigation frequency band: 108.000 ~ 117.975 MHz
CDI 4		Selects the CDI feature when using an active VOR frequency.
KEY LOCK 5		Turns the Key Lock feature on and off.
BATT SAVE 6		Turns the Battery Save feature on and off.
TO 7		Changes the CDI/DVOR navigational information to "TO" when using an active VOR frequency.
LOCK OUT 8		Turns the memory channel Lock Out function on and off.
DUP 9		Turns the duplex feature on and off.
EMG 121.5 0		Selects the 121.5 airband emergency frequency.

15

BASIC OPERATION

● BASIC OPERATION

◆ Power, Volume & Squelch

Power On & Off

- 1) Rotate the Volume, On/Off knob CW to turn ON power.
- 2) Rotate the Volume, On/Off knob CCW to turn OFF power.

Volume Adjust

- 1) Rotate the Volume, On/Off knob CW to increase volume.
- 2) Rotate the Volume, On/Off knob CCW to decrease volume.

Squelch Adjust

- 1) Rotate the Squelch knob full CW to close squelch.
- 2) Rotate the Squelch knob full CCW to open squelch.
- 3) Rotate the Squelch knob between full open and closed to desired squelch threshold point.
 - Squelch threshold point may vary depending on signal strength.

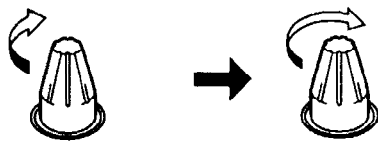

◆ Airband Frequency Selection

- Radio power must be ON.

Using The Keypad

- 1) Press [CLR] to verify you are in the airband mode.
- 2) Press the desired 5 keys in sequence to input frequency.
 - Enter [1] as the first key in sequence.
 - If an incorrect number is entered, press [▼ • BS] to back space and reenter number, or, press [CLR] to clear entire entry, then start again.
 - Press [▲ • ENT] to enter consecutive zero digits.
 - Enter [2], [5], [7] or [0] as the 5th/final number.
- 3) Press [▲] to scroll up, press [▼] to scroll down.
 - Press and hold [▲] or [▼] for two seconds to rapidly scroll.

Using The Channel Selector

- 1) Press [CLR] to verify you are in the airband mode.
- 2) Rotate the channel selector CW to scroll up, CCW to scroll down.
 - To select MHz tuning steps press [F] then rotate the channel selector to desired frequency.
 - To select kHz tuning steps press [F] again then rotate the channel selector to desired frequency.

16

BASIC OPERATION

◆ Weatherband Channel Selection

- JRC radios can monitor NOAA weather broadcasts found throughout North America. There are ten weather channels to select from. Some areas of North America are not able to receive NOAA broadcasts.
- Radio power must be ON.

- 1) Press [F] then [A/S • WX] to access the weatherband mode.
- 2) Enter the desired channel number.
 - Example: For WX-01, press [0] then [1].
 - Press [▲] to scroll up, press [▼] to scroll down.
 - Press and hold [▲] or [▼] for two seconds to rapidly scroll.
 - Rotate the channel selector CW to scroll up, CCW to scroll down.
- 3) Press [CLR] to exit weatherband mode and return to previous mode.

◆ Emergency 121.5 Selection

- 1) Press [F] then [0 • EMG 121.5], the emergency frequency appears in the display.
- 2) Press [CLR] to exit emergency mode and return to previous mode.

◆ Receiving & Transmitting

- Radio power must be ON with volume and squelch adjusted to desired levels.

Receiving

- 1) Select airband frequency or weather channel.
 - When a signal is received the green RX lamp will illuminate.

Transmitting

- 1) Select airband frequency.
 - The unit will not transmit on NAV frequencies or weather channels.
- 2) Press the PTT to transmit. Release PTT after transmitting.
 - When transmitting the red TX lamp will illuminate.

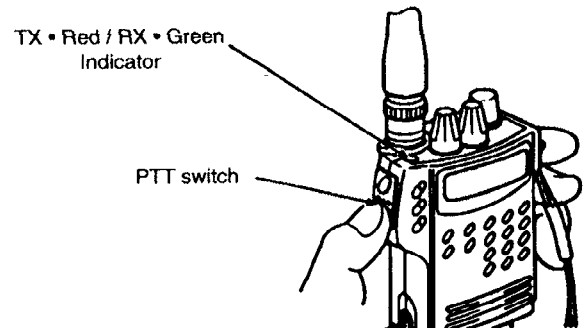

17

SCANNING

● SCANNING

- Set scan Pause to desired setting.
- Radio power must be ON with volume and squelch adjusted to desired levels.

◆ Scan Pause Feature

- There are two distinct ways the JRC radios can be programmed to scan. Below is an explanation of Pause OFF and Pause ON. *Read them carefully.*

Pause OFF: When scanning and an active frequency is received, the unit will remain on that frequency for as long as that frequency is active. If the signal is lost the unit will continue scanning. *The scan indicator in the display will remain on during scanning when Pause OFF is selected.*

Pause ON: When scanning and an active frequency is received, the unit will remain on that frequency for five seconds, then the unit will automatically start scanning again. *The scan indicator in the display will flash on and off during scanning when Pause ON is selected.*

Selecting Pause ON or OFF

- 1) Press and hold [F] for two seconds, the function indicator appears and begins flashing.
- 2) Press [Scan], (P OFF) or (P ON) will appear in the display.
- 3) Press [▼] to toggle between (P OFF) and (P ON). Select desired setting.
- 4) Press [ENT] to enter desired setting.

When Scanning, To Change Scan Direction:

- Press [▲] to scan up, press [▼] to scan down.
- Rotate the channel selector CW to scan up, CCW to scan down.

◆ Com Band Scanning

- 1) Press [CLR] to verify you are in the airband mode.
- 2) Enter desired Com frequency.
- 3) Press [SCAN], the unit immediately starts scanning the Com frequency band (118.000 ~ 136.975 MHz), the scan indicator appears in the display.
- 4) Press [CLR] to stop scanning.

◆ Nav-Scan

- 1) Press [CLR] to verify you are in the airband mode.
- 2) Press [F] then [3 • NAV-SCAN], the unit immediately starts scanning the Nav frequency band (108.000 ~ 117.975 MHz), the scan indicator appears in the display.
- 3) Press [CLR] to stop scanning.

◆ Weatherband Scanning

- 1) Press [F] then [A/S • WX] to access the weatherband mode.
- 2) Press [SCAN], the unit immediately starts scanning, the scan indicator appears in the display.
- 3) Press [CLR] to stop scanning.

18

SCANNING

◆ *Memory Scanning*

- Only memory channels that are programmed can be scanned.
 - To Lock Out specific memory channels from being scanned refer to Memory programming, Lock Out feature.
- 1) Press [Memory] to access memory mode.
 - 2) Press [SCAN], the unit immediately starts scanning, the scan indicator appears in the display.
 - 4) Press [CLR] to stop scanning.

Group Memory Scanning

- The unit can be programmed to scan the memory channels in groups of 10.
 - Example: Memory No. 23 selected. Memory locations 20 - 29 will be scanned.
- 1) Press and hold [F] for two seconds, the function indicator appears and begins flashing.
 - 2) Press [4], (4 ALL) or (4 GRP) will appear in the display.
 - 3) Press [▼] to toggle between (4 ALL) and (4 GRP). Select desired setting.
 - (4 ALL) Selected: Unit will scan all memory channels.
 - (4 GRP) Selected: Unit will scan in groups of 10.
 - 4) Press [ENT] to enter desired setting.

◆ *Dual-Watch Scanning*

- Dual-Watch is a useful unique feature that enables the user to monitor the "active" and "standby" frequencies.
 - Memory channels cannot be used in the Dual-Watch mode.
- 1) Press [CLR] to verify you are in the airband mode.
 - 2) Enter the desired "secondary" airband frequency or weather channel.
 - 3) Enter the desired "active" airband frequency or weather channel.
 - The last frequency/channel entered is always referred to as the "Active" frequency/channel.
 - 4) Press [F] then [2 • DUAL-W], the unit immediately starts scanning between the "active" and "standby" frequencies, the scan indicator appears in the display.
 - "ACT" is displayed when the "active" frequency is being scanned.
 - "STBY" is displayed when the "standby" frequency is being scanned.

MEMORY

● MEMORY

- Radio power must be ON with volume and squelch adjusted to desired levels.
- 100 memory channels available, 00 through 99.

◆ *Instant Memory Write*

- The displayed frequency/channel will be instantly programmed to the lowest number vacant memory channel available.
- 1) Enter desired airband frequency or weather channel.
 - 2) Press [IMW], the memory indicator will flash and the memory channel number that is being programmed will be displayed for one second.
 - For adding an alpha/numeric comment see "Alpha Numeric Comment Programming".

Using Instant Memory Write While Scanning

- While scanning airband frequencies or weather channels do the following:
- 1) Press [CLR] to stop the scan process. The displayed frequency/channel can now be programmed to memory.
 - 2) Press [IMW], the memory indicator will flash and the memory channel number that is being programmed will be displayed for one second.
 - 3) Press [Scan] to continue scanning the selected mode.

◆ *Programming Memory Manually*

- 1) Enter desired airband frequency or weather channel.
- 2) Press [F] then [IMW • MW], the memory indicator flashes in the display.
- 4) Enter the desired memory channel number, 00 through 99.
 - Example Keypad: For channel 52, press [5] then [2].
 - Example Channel Selector: Rotate the channel selector CW to scroll up, CCW to scroll down.
- 5) Press [▲ • ENT]], four dashed lines are displayed, the first segment is flashing.
 - For entering a four character alpha/numeric comment continue on with step 6.
 - For entering a memory channel without an alpha/numeric comment skip to step 8.
- 6) Rotate the channel selector CW or CCW so that the desired alpha/numeric character is displayed.
 - The character being programmed will be flashing.
 - Available characters: Letters (capital): A through Z, Numbers: 1 through 0, and a selection of miscellaneous characters.
- 7) Press [A/S] to advance to the next segment. Repeat step 6 and 7 to enter up to four alpha/numeric characters.
 - To correct a segment press [A/S] repeatedly to select the desired segment.
- 8) Press [▲ • ENT]. The channel is now programmed.

Displaying Alpha Numeric Characters

- When in the memory mode press [IMW] to toggle between frequency/channel display and alpha/numeric display.
- **Please Note:** When the unit is programmed to view alpha/numeric display and the weather mode is activated the actual weatherband frequencies will be displayed along with the weather channel number to the right of the frequency. To remove the weatherband frequencies and return to view the weather mode with the "WX-" display, do the following: Press [Memory] then [IMW], this resets the memory mode to view frequency/channel display. Return to the weather mode to view the "WX-" display.

◆ **Alpha Numeric Comment Programming**

Editing alpha/numeric characters to existing memory channels.

- 1) Select memory mode and enter desired memory channel number to be edited.
- 2) Press [IMW] to view alpha/numeric display.
- 3) Press and hold [F] for two seconds, the function indicator appears and begins flashing.
- 4) Press [IMW], the first segment begins flashing.
- 5) Refer to "Programming Memory Manually" steps 6, 7 & 8.

Adding alpha/numeric characters to memory channels that were entered via Instant Memory Write.

- **IMPORTANT:** Before you start this process make sure the unit is in "memory mode" and programmed to view the "alpha/numeric display".
- 1) Select the desired memory channel number to be programmed.
 - 2) Press and hold [F] for two seconds, the function indicator appears and begins flashing.
 - 4) Press [IMW], the first segment begins flashing.
 - 5) Refer to "Programming Memory Manually" steps 6, 7 & 8.

◆ **Accessing Memory Channels**

- When in the memory mode press desired numbered keys in sequence. Example: For channel 52, press [5] then [2].
- Press [▲] to scroll up, press [▼] to scroll down.
- Rotate the channel selector CW to scroll up, CCW to scroll down.
- Only memory channels that are programmed can be viewed.

◆ **Lock Out Feature**

- Memory channels can be programmed to the "skipped" or "Locked Out" of the scan process.
 - The Lock Out feature is operational only during the scan process.
- 1) Select memory mode and enter desired memory channel number to be Locked Out.
 - 2) Press [F] then [8 • Lock Out], the Lock Out indicator appears in the display.
 - To remove Lock Out from a memory channel repeat step 2, the Lock Out indicator disappears from the display.

◆ **Deleting a Memory Channel**

- 1) Select memory mode and enter desired memory channel number to be deleted.
- 2) Press and hold [F] for two seconds, the function indicator appears and begins flashing.
- 4) Press and hold [CLR], the displayed information disappears and five dashed lines will appear signifying that the channel has been deleted.

● **MISC. OPERATIONS**

- This section explains the miscellaneous features/functions and operations.....
- Radio power must be ON with volume and squelch adjusted to desired levels.

◆ **Duplex**

- The Duplex feature is intended to allow the user to transmit on a Com frequency to a Flight Service Station and receive over a Nav frequency.
- 1) Enter the desired Com frequency.
 - 2) Enter the desired Nav frequency.
 - 3) Press [F] then [9 • DUP], the Duplex indicator appears.
 - 4) Press the PTT to transmit on the Com frequency.
 - While pressing the PTT the Com frequency is displayed.
 - Release the PTT and the Nav frequency is displayed.
 - To exit Duplex repeat step 3, the Duplex indicator will disappear.

MISC. OPERATIONS

◆ **Battery Save**

- When the Battery Save function is activated it will extend the life of the battery.

- 1) Press [F] then [6 • BATT SAVE], the SAVE indicator appears.
 - To disable Battery Save repeat step 1.

◆ **Key Tone**

- The "BEEP" tones that sound each time a button is pressed can be turned on and off.

- 1) Press [F] then [▲ • BEEP], no indicator will appear.
 - Repeat step 1 to turn BEEP tone on and off.

◆ **Automatic Noise Limiter**

- JRC radios feature advanced ANL circuitry. When activated the ANL circuit will filter out unwanted aircraft ignition and static noise.
- When ANL is activated a slight drop in audio volume will occur.

- 1) Press [F] then [CLR • ANL], the ANL indicator appears.
 - To disable ANL repeat step 1.

◆ **Lamp / Backlighting**

- The display and keypad backlighting can be turned on and off or programmed to stay on continuously.

Lamp Momentary Operation

- 1) Press [LAMP], the backlighting turns on.
 - The backlighting automatically turns off after five seconds if no key is pressed. If keys are pressed, the backlighting will remain on then automatically turn off five seconds after the last key has been pressed.

Lamp Continuous Operation

- 1) Press [F] then [LAMP], the backlighting turns on.
 - The Backlighting will remain on.
- 2) Press [LAMP] to turn backlighting off.

◆ **Key Lock**

- The channel selector along with all keys except the function, lamp and PTT buttons become inoperative.

- 1) Press [F] then [5 • KEY LOCK], the Key Lock indicator appears.
 - To disable Key Lock repeat step 1.

MISC. OPERATIONS

◆ **Battery Selector**

- JRC radios feature advanced battery consumption circuitry. For optimum radio performance and to extend battery life the user may select the type of battery that is being used. (Rechargeable or alkaline)

- 1) Press and hold [F] for two seconds, the function indicator appears and begins flashing.
- 2) Press [1], either (1 1) or (1 2) appears in the display.
- 3) Rotate the channel selector or press [▼] to toggle between (1 1) and (1 2).
 - *Alkaline Battery*: Program the unit to (1 1) when using an alkaline battery pack.
 - *Rechargeable Battery*: Program the unit to (1 2) when using a rechargeable battery pack.
- 4) Press [ENT] to activate selection.

◆ **Radio Reset**

- This operation will rest the radio CPU to factory settings and will *ERASE ALL MEMORY CHANNELS*.

- 1) With the radio turned OFF press and hold [F] and [CLR].
- 2) Turn the radio ON.
- 3) Release [F] and [CLR], the radio is reset to factory settings and the *MEMORY CHANNELS HAVE BEEN ERASED*.

◆ **Low Power / High Power**

- The radio output power can be programmed to High Power (5 watts PEP) for transmitting long distances or to Low Power (1 watt PEP) to conserve battery life when transmitting short distances.

- 1) Press and hold [F] for two seconds, the function indicator appears and begins flashing.
- 2) Press [5], the Low Power indicator appears in the display.
 - To return to High Power repeat sets 1 and 2. The Low Power indicator will disappear.

◆ **Com Frequency Steps**

- The Com Frequency Steps can be programmed to either 10, 20, 25, 50 or 100 kHz steps.
- It is recommended that you set your radio to 25 kHz steps for normal use.

- 1) Press and hold [F] for two seconds, the function indicator appears and begins flashing.
- 2) Press [2], the number two (2) appears followed by the current frequency step setting. Example: (2 25) = 25 kHz
- 3) Rotate the channel selector or press [▼] to select the desired setting.
- 4) Press [ENT].

◆ **Nav Frequency Steps**

- The Nav Frequency Steps can be programmed to either 10, 20, 25, 50 or 100 kHz steps.
 - It is recommended that you set your radio to 25 kHz steps for normal use.
- 1) Press and hold [F] for two seconds, the function indicator appears and begins flashing.
 - 2) Press [3], the number three (3) appears followed by the current frequency step setting. Example: (3 25) = 25 kHz
 - 3) Rotate the channel selector or press [▼] to select the desired setting.
 - 4) Press [ENT].

● **VOR OPERATION** (JHP-520 ONLY)

- JRC assumes that the user understands the terminology and theory associated with VOR navigation.
- The JHP-520 Nav/Com VOR navigation information should NOT be used as your primary means of navigation.
- Localizer frequencies are not able to display DVOR or CDI information.
- LOC appears in the Course Display when a localizer frequency is displayed.
- Radio power must be ON with volume and squelch adjusted to desired levels.

◆ **DVOR Mode**

- Three dashed lines are displayed in the Course Display if the signal is lost or becomes too weak to navigate.
- 1) Enter the desired Nav frequency. The DVOR indicator appears and the Course Display becomes active. Also, either the TO or FROM indicator appears.
 - 2) Press [F] then [7 • TO] to select TO. The TO indicator appears.
 - The Course Display will show the aircrafts bearing TO the VOR station.
 - 3) Press [F] then [▼ • FROM] to select FROM. The FROM indicator appears.
 - The Course Display will show the aircrafts radial FROM the VOR station.

25

VOR OPERATION

◆ **CDI Mode**

- When CDI mode is selected the frequency cannot be changed. Press [F] then [1 • DVOR] to exit CDI mode and access other airband frequencies.
- 1) Enter the desired Nav frequency. The DVOR indicator appears.
 - 2) Press [F] then [4 • CDI] to select CDI mode. The CDI indicator appears and the Course Display and Course Deviation Scale become active.
 - When in CDI mode the channel selector, numbered keypad and [▲] [▼] are used to enter the desired course in the Course Display.
 - OFF is displayed in the Course Display if the signal is lost or becomes too weak to navigate.

Navigating TO a VOR Station in CDI mode.

- 1) Press [F] then [7 • TO] to select TO. The TO indicator appears.
- 2) Use the channel selector or keypad to enter the desired bearing TO the station.
 - The Course Display displays the selected bearing TO the station.
 - The Course Deviation Scale displays the aircrafts left/right relation to the bearing.
 - After passing over the VOR station the TO indicator will automatically change to FROM.

Navigating FROM a VOR Station in CDI mode.

- 1) Press [F] then [▼ • FROM] to select FROM. The FROM indicator appears.
- 2) Use the channel selector or keypad to enter the desired radial FROM the station.
 - The Course Display displays the selected radial FROM the station.
 - The Course Deviation Scale displays the aircraft's left/right relation to the radial.

Automatic CDI centering function.

- The JHP-520 Nav/Com can automatically center the CDI calculating the new direct bearing TO or the actual radial FROM the VOR station.

Auto CDI TO:

- 1) Press [F] then [7 • TO], the CDI is centered, the new bearing TO the station is shown in the Course Display.

Auto CDI FROM:

- 1) Press [F] then [▼ • FROM], the CDI is centered, the new radial FROM the station is shown in the Course Display.

Exit CDI mode.

- 1) Press [F] then [1 • DVOR] to exit CDI mode and access other airband frequencies.

26

● TROUBLESHOOTING

No Power

- Battery is exhausted • Poor DC power connection •

No Audio

- Readjust squelch • Readjust volume •
- Disconnect headset adapter/speaker mic •

Transmitting inoperative

- Exit weatherband • Exit Navband •

Frequency cannot be entered

- Unlock "Key Lock" • Exit emergency mode • Exit CDI mode •

Scan inoperative

- Readjust squelch • Exit emergency mode • Exit CDI mode •

Error messages

If any of the following messages are displayed it is recommended that you reset the radio CPU.

(PL LE) (ER RI) (ER R2) (ER R3)

If the error message remains after resetting the radio CPU return the radio to your dealer or to JRC/Edmo for service. See warranty information page 4.

